

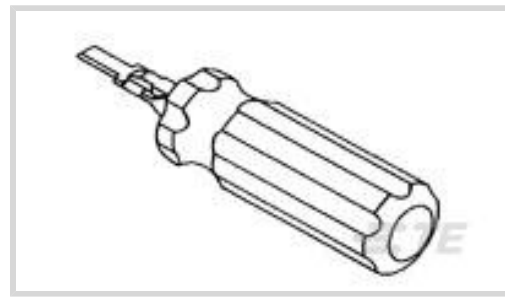

Application Tooling > Insertion & Extraction Tools



Insertion & Extraction Tool Type: **Contact Extraction**

Insertion & Extraction Tool Application: **Contact-to-Housing**

Features

Product Type Features

Insertion & Extraction Tool Type	Contact Extraction
Insertion & Extraction Tool Application	Contact-to-Housing

Product Compliance

[For compliance documentation, visit the product page on TE.com>](#)



EU RoHS Directive 2011/65/EU	Compliant
EU ELV Directive 2000/53/EC	Out of Scope
China RoHS 2 Directive MIIT Order No 32, 2016	No Restricted Materials Above Threshold
EU REACH Regulation (EC) No. 1907/2006	Current ECHA Candidate List: JUNE 2022 (224) Candidate List Declared Against: JAN 2022 (223) Does not contain REACH SVHC
Halogen Content	Low Halogen - Br, Cl, F, I < 900 ppm per homogenous material. Also BFR/CFR/PVC Free
Solder Process Capability	Not reviewed for solder process capability

Product Compliance Disclaimer

This information is provided based on reasonable inquiry of our suppliers and represents our current actual knowledge based on the information they provided. This information is subject to change. The part numbers that TE has identified as EU RoHS compliant have a maximum concentration of 0.1% by weight in homogenous materials for lead, hexavalent chromium, mercury, PBB, PBDE, DBP, BBP, DEHP, DIBP, and 0.01% for cadmium, or qualify for an exemption to these limits as defined in the Annexes of Directive 2011/65/EU (RoHS2). Finished electrical and electronic equipment products will be CE marked as required by Directive 2011/65/EU. Components may not be CE marked. Additionally, the part numbers that TE has identified as EU ELV compliant have a maximum concentration of 0.1% by weight in homogenous materials for lead, hexavalent chromium, and mercury, and 0.01% for cadmium, or qualify for an exemption to these limits as defined in the Annexes of Directive 2000/53/EC (ELV). Regarding the REACH Regulation, the information TE provides on SVHC in articles for this part number is based on the latest European Chemicals Agency (ECHA) 'Guidance on

requirements for substances in articles' posted at this URL: <https://echa.europa.eu/guidance-documents/guidance-on-reach>

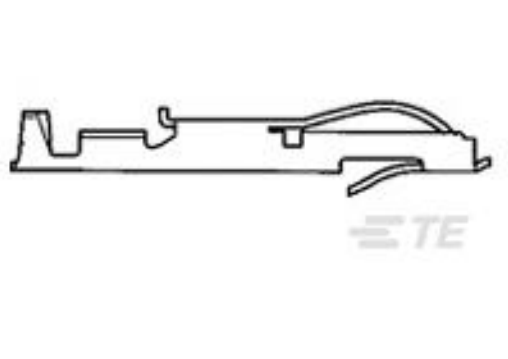
Compatible Parts

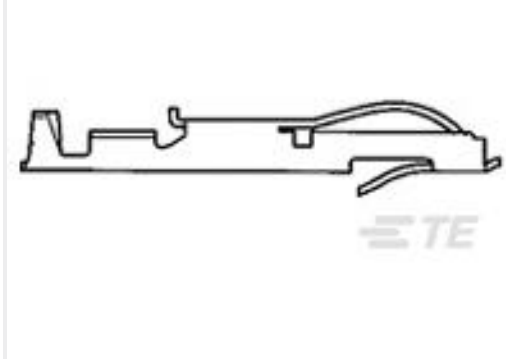
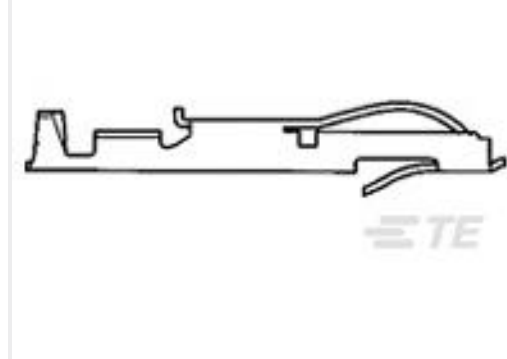
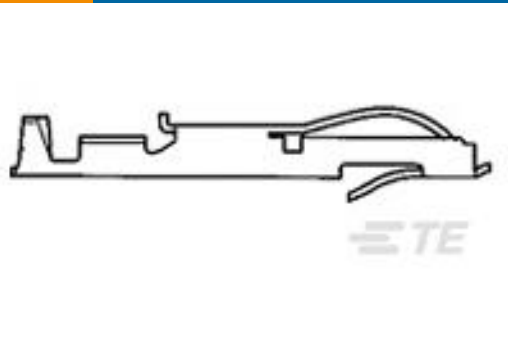
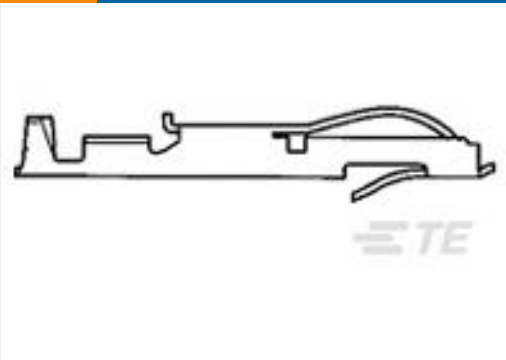
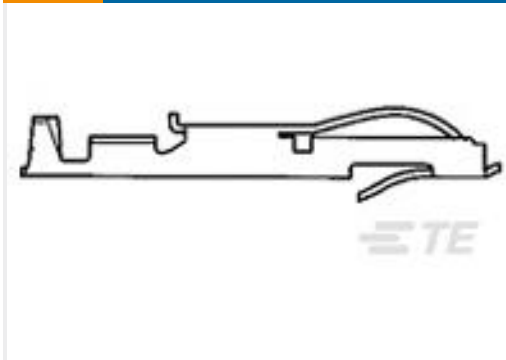
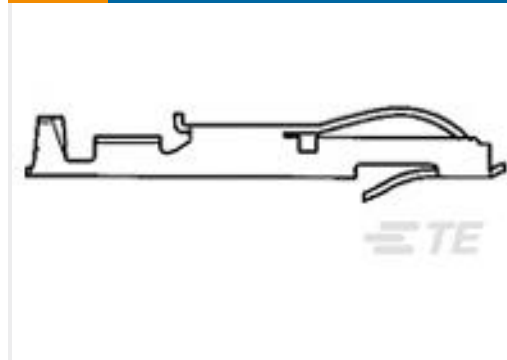
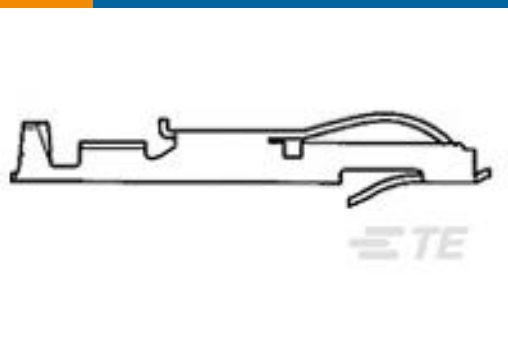
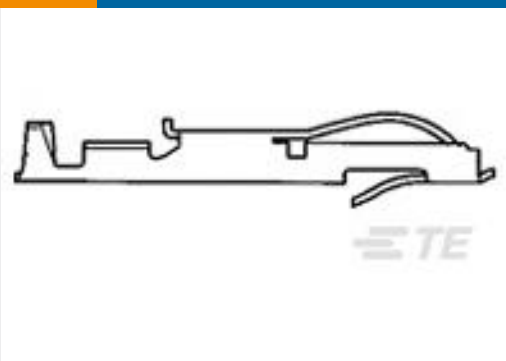
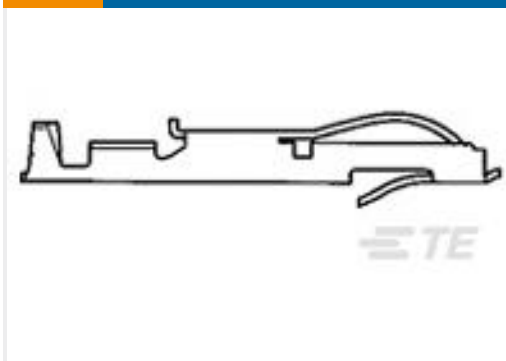
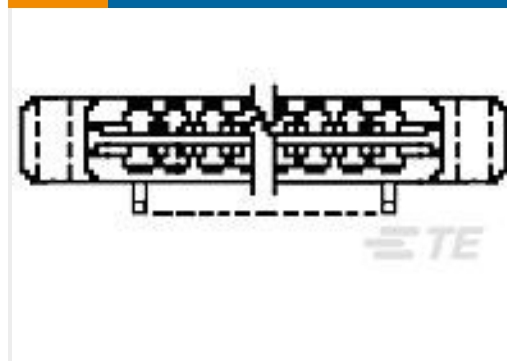
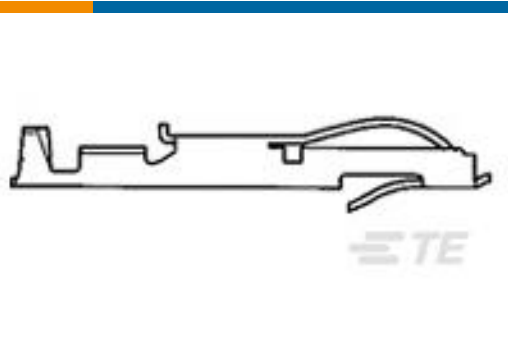
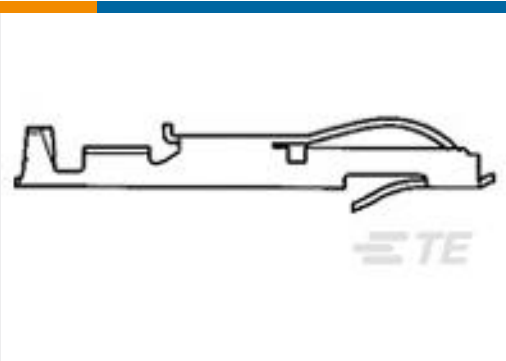
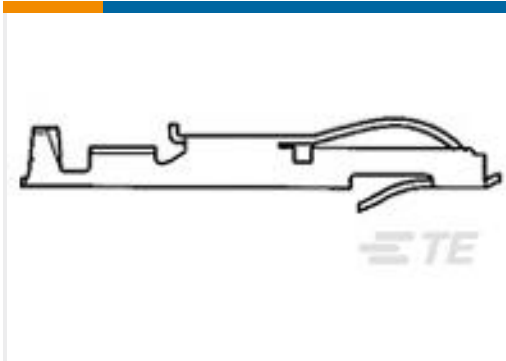
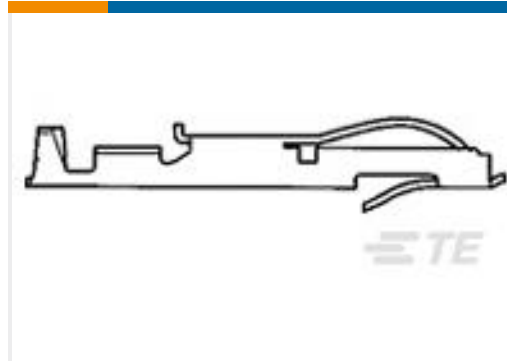
 <p>TE Part # 583853-8 TWIN LEAF TERMINAL STRIP</p>	 <p>TE Part # 5-583853-3 TWIN LEAF TERM. STRIP CSTL</p>	 <p>TE Part # 583853-2 CONT.CRP.SNAP TW.LF.STRIP</p>	 <p>TE Part # 1-583853-1 TWIN LF CONT IS 20-24 AU</p>
 <p>TE Part # 583853-4 TWIN LF CONT IS 20-24 AU</p>	 <p>TE Part # 583853-5 TWIN LF CONT IS 20-24 AU</p>	 <p>TE Part # 583875-2 TWIN LEAF TERM.</p>	 <p>TE Part # 1-583853-0 CONT.TW.LF.CRP.SNAP STRIP</p>
 <p>TE Part # 5-583616-2 CONT.CRP.SNAP TW.LF. STRIP</p>	 <p>TE Part # 5-583853-4 TWIN LF CONT IS 20-24 AU</p>	 <p>TE Part # 5-583875-6 LP OF 5-583875-5</p>	 <p>TE Part # 583545-1 CONN AMP LEAF 156 C/L 15 POS</p>
 <p>TE Part # 5-583616-3 CONT.CRP.SNAP TW.LF. STRIP</p>	 <p>TE Part # 5-583616-4 TWIN LF CONT IS 24-28 AU</p>	 <p>TE Part # 5-583875-5 TWIN LEAF TERM.</p>	 <p>TE Part # 583616-3 CONT. CRP.SNAP TW.LF STRIP</p>

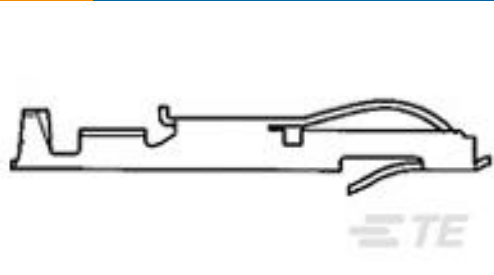

TE Part # 583616-8
TWIN LEAF TERM.



TE Part # 583875-3
TWIN LEAF CONTACT



TE Part # 1-583616-0
CONT.CRP.SNAP TW.LF. STRIP

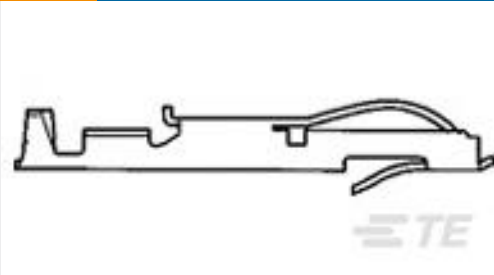

TE Part # 5-583853-5
TWIN LF CONT IS 20-24 AU

Also in the Series | AMP Twin-Leaf



Insertion & Extraction Tools(1)



Wire-to-Board Connector Assemblies & Housings(27)



Wire-to-Board Connector Contacts(15)

Documents

Instruction Sheets

[Instruction Sheet \(U.S.\)](#)

English

[Extraction Tool for Twin Leaf Contacts](#)

English